

TYPE

CATALOG #

PROJECT

NOTES



BV - Beveled

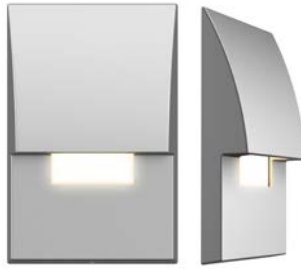

CV - Curved

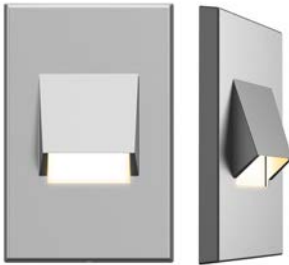

FT - Flat



RD - Round

LED RECESSED LUMINAIRES

rHatch-8

The versatile rHatch-8 wall luminaire is available with four faceplate options to maximize design flexibility in a range of applications.

Quick Facts

- Tamper-resistant features
- Glare-free shielding
- Die-cast aluminum
- Two-layer marine-grade anodization and powder coat finish
- Cree® integrated LEDs
- Compatible with Luxor® technology
- Phase and PWM dimmable
- Input voltage: 10-15 V

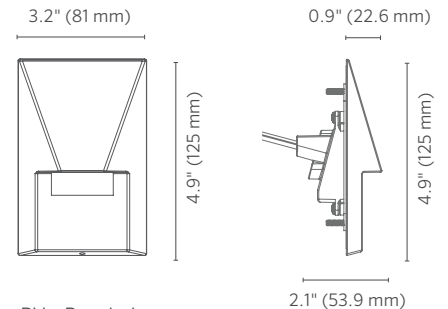

BV - Beveled

(Measurements are the same for all four faceplate styles)

rHatch-8 SPECIFICATIONS

Output	1LED	3LED	ZDC
Total Lumens*	48	78	60
Input Voltage	10-15V	10-15V	11-15V
Input Power (W)	2.0	4.2	6.0
VA	2.4	4.5	7.2
Efficacy (Lumens/Watt)	24	19	10
Color Rendering Index (CRI)	80+	80+	80+
Maximum Candela	53	73	56
Dimming	PWM, Phase**	PWM, Phase**	--
Luxor Compatibility			
Default	Zoning	Zoning	--
ZD Option	Zoning/Dimming	Zoning/Dimming	--
ZDC Option	--	--	Zoning/Dimming/Color
Useful LED Life (L90)	55,000 hrs	55,000 hrs	55,000 hrs

* Measured using the 3,900K CCT lens. Multipliers for other CCTs include 0.80 (2,700K), 0.65 (4,500K), and 0.65 (5,200K).

** For optimal performance, use a trailing-edge, phase-cut dimmer.

Holm

Holm was from an industry demand for a comprehensive offering of distinctive line- and low-voltage luminaires for the commercial market. Our products are designed to meet required specifications while echoing the aesthetics of each project. Holm is a Hunter Industries company with more than three decades of engineering expertise, now bringing its Luxor technology to the commercial architectural and landscape lighting market.

Materials

Die-cast A380 aluminum body with stainless steel setscrews, mounting brackets, and fasteners.

Lamp

Integrated module with Cree LEDs. Gold-plated connectors and conformal coating for maximum reliability and corrosion resistance. Proprietary onboard intelligent driver uses firmware-controlled temperature regulation, maximizing LED life. Field upgradeable and replaceable, the LEDs are rated to 55,000 hrs. Maximum drive current: 1 A.

Optics

Polycarbonate color temperature adjustment lenses included with luminaire: 2,700K (preinstalled), 3,900K (no lens), 4,500K, and 5,200K. Beam angle is calculated using LM-79 method for SSL luminaires.

Socket

Socket contains MoistureBlock™ technology, preventing moisture from wicking up into sealed areas of the luminaire.

Wiring

18 AWG (1 mm); SPT-1W; 220°F (105°C); 300V; 10' (3 m) length.

Power

Input 0-15 VAC/VDC, 50/60 Hz. Remote transformer required (specify separately).

Housing

Die-cast A380 aluminum body with capacity for 1LED, 3LED, or ZDC integrated LEDs.

Weight

1.0 lb. (0.5 kg)

Faceplate

Die-cast A380 aluminum faceplate with UV-stabilized acrylic lens.

Lens

UV-stabilized acrylic with shock resistance and high tolerance for thermal expansion and stress.

Finish

Two-layer protection of sulfuric acid anodization and polyester TGIC powder coat, providing superior outdoor weathering in all conditions. Tested to ASTM standards.

Hardware

Stainless steel machine screws

Ambient Operating Temperature

0°F to 140°F (-17°C to 60°C)

Control

ZD or ZDC utilizes Luxor technology to zone luminaires in up to 250 groups, dim each group in 1% increments between 0 and 100%, or change to one of 30,000 colors with RGBW LEDs. Select the ZD option for zoning/dimming or ZDC for zoning/dimming/color. Standard luminaire is zoneable with ZDclick™.

Sustainability

Innovation meets conservation in the design and manufacturing of our products. Where we can, we use recycled materials while maintaining superior functionality. Our LED products provide high-quality light at optimal energy efficiency, lifespan, and durability.

Installation Requirements

Designed for recessed installation in a vertical surface. Included mounting bracket fits most single-gang junction boxes.





Warranty

5-year limited warranty.

Listings



rHatch-8 ORDERING INFORMATION

Luminaire-Size	Luxor Option	Output	Faceplate	Finish	
rHCH-8	■ [default] Zone	■ 1LED 48 Lumens	■ BV Beveled	■ BZ Bronze Metallic	
	■ ZD Zone/Dim	■ 3LED 78 Lumens	■ CV Curved	■ SV Silver	
	■ ZDC Zone/Dim/Color	■ [default ZDC option] 60 Lumens	■ FT Flat	■ FB Black	
			■ RD Round	■ FW Flat White	
				■ RL RAL Color	

EXAMPLE LUMINAIRE CONFIGURATION: rHCH-8-ZD-3LED-CV-BZ

rHCH-8 - - - -

ACCESSORIES: Specify Separately

Accessories	Code
■ SINGLE-GANG JUNCTION BOX <i>New work (18 in³/295 cm³)</i>	JB1GNWNM
■ DIMMABLE TRANSFORMER <i>60W, 120V input, 12V output</i>	ST120DIM
■ TRANSFORMER <i>80W, 277V input, 12V output</i>	ST277

rHatch-8 1LED Isofootcandle Plot

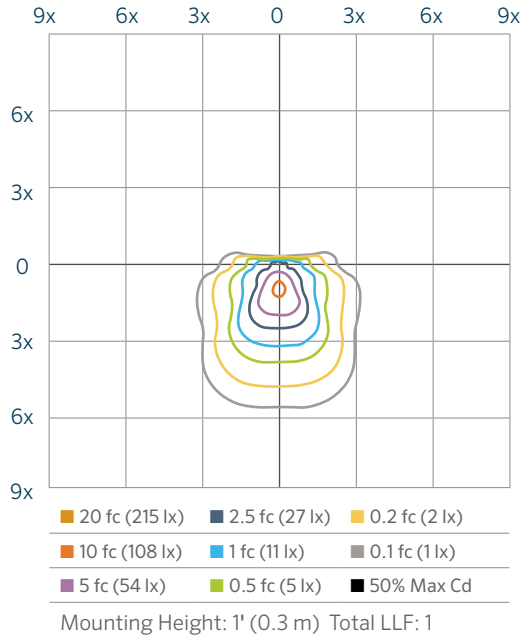

rHatch-8 3LED Isofootcandle Plot

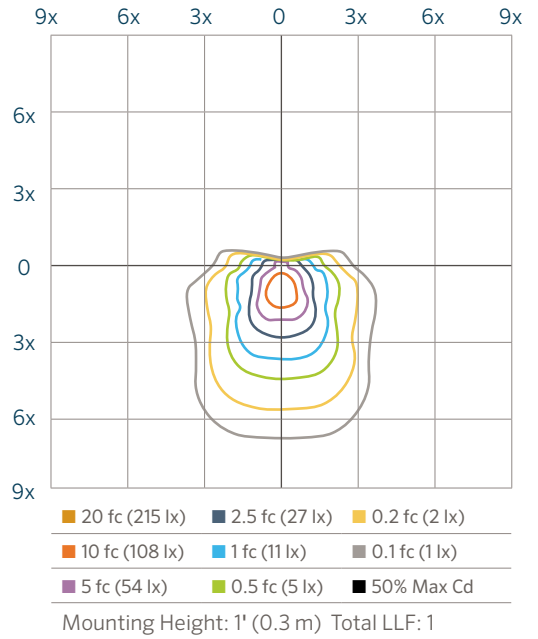

rHatch-8 ZDC Isofootcandle Plot

